



LEVTECH

User Manual



Isolated Signal Converter **LSP-IVC and LSP-IAC**



Lueta Nr. 319, Romania

+40758576007

office@levtech.ro

www.levtech.ro



Table of Contents

PREFACE.....	3
Document Revisions	4
Approvals.....	4
1. INTRODUCTION.....	5
1.1. General Information	5
1.2. Support and Services.....	5
1.3. Disposal Remarks.....	5
2. SAFETY INSTRUCTIONS.....	6
2.1. Symbols.....	6
2.2. Receipt and unpacking.....	6
2.3. Environment.....	6
2.4. Mounting.....	6
2.5. Cleaning	7
3. DESCRIPTION.....	8
4. FEATURES	8
5. INSTALLATION AND WIRING	9
5.1. Installation on TS-35 DIN Rail.....	9
5.2. Connections with Screw Terminals.....	9
6. SPECIFICATIONS	10
7. CONFIGURATION TYPE AND ORDER CODE.....	11
8. DIMENSIONS.....	11
9. TERMINAL DESIGNATION.....	12
10. ELECTRICAL DIAGRAMS.....	13
11. APPLICATIONS.....	15
12. OPERATION AND MAINTENANCE.....	16
12.1. Operation.....	16
12.2. Maintenance	16
13. WARRANTY DISCLAIMER	16
14. CONTACT INFORMATION	17

PREFACE

Thank you for selecting our product!

This User Manual contains information needed for proper installation, operation, and maintenance of your product. A thorough understanding of these simple instructions will help you get the most of your product.

This document should be read thoroughly, and the safety instructions described in this manual should be followed carefully. If you have questions or concerns about the operation and maintenance of this product, please contact our customer support.

If a problem arise with the product, check if you followed the installation steps correctly. If the problem persists, contact an authorized Levtech dealer or our customer support.

All information in this User Manual is based on the latest product information available at the time of printing approval. Levtech reserves the right to make changes at any time without notice and without incurring any obligation.

Please always keep this manual together with the isolator as a reference to everyone who uses this product.

Document Revisions

Date	Version Number	Document Changes
11-03-2021	1.0	Initial draft
13-04-2021	2.0	Overall improvements
15-04-2021	3.0	Application examples added
13-05-2021	4.0	Wiring diagram added

Approvals

This document requires following approvals:

Name	Title
Levi Mihaly	General Manager

1. INTRODUCTION

1.1. General Information

This manual is the designated User Manual for the installation, safe operation, and maintenance of your product. It is divided into nine chapters covering general information, safety instructions, how to safely install and operate the product, maintenance, warranty, and contact information.

All personnel involved in the installation, operation, and maintenance of this equipment should read and understand this manual, particularly its safety instructions. Substandard performance and longevity, property damage, and personal injury may result from not knowing and following these instructions.

In order to ensure long product life, Levtech recommends that you utilize the product and perform maintenance by correctly following the instructions described in this guide. The manufacturer's warranty does not cover any damage resulting from the neglect of these instructions.

Levtech assumes no liability for damage caused by operation contrary to what is specified in this operating manual.

1.2. Support and Services

For information about further questions that are not answer in this manual, additional materials, and support, please contact:

 Lueta Nr. 319, Romania

 +40758576007

 office@levtech.ro

 www.levtech.ro

1.3. Disposal Remarks



DO NOT dispose of the product with domestic waste!

Electronic devices have to be disposed of according to the regional directives on electronic and electric waste disposal. In case of further questions, please consult your supplier. The supplier may take care of proper disposal.



2. SAFETY INSTRUCTIONS

2.1. Symbols

 WARNING	This symbol indicates information that, if ignored, could result possibly in personal injury or even death due to incorrect handling.
 CAUTION	This symbol indicates information that, if ignored, could possibly result in personal injury or physical damage due to incorrect handling.
NOTICE	Indicates information considered important, but not hazard-related.

2.2. Receipt and unpacking

Unpack the device without damaging it and check whether the device type corresponds to the one ordered. The packing should always follow the device until this has been permanently mounted.

2.3. Environment

Avoid direct sunlight, dust, high temperatures, mechanical vibrations and shock, and rain and heavy moisture.

2.4. Mounting

- Only technicians who are familiar with the technical terms, warnings, and instructions in the manual and who are able to follow these should connect the device.
- Mounting and connection of the device should comply with national legislation for mounting of electric materials, i.e. wire cross section, protective fuse, and location. Descriptions of input / output and supply connections are shown in this installation guide and on the side label.
- Use this device only in accordance with this instruction manual, as well as all applicable local and national laws and regulations. Only allow this device to be installed, operated, maintained, repaired, etc. by others who have also read and understood the user manual.
- Do not allow minors, untrained personnel, or personnel suffering from physical or mental impairment that would affect their ability to follow this manual to install, operate, maintain, or repair this device.
- Any untrained personnel who might be near the device while it is in operation **MUST** be informed that it is dangerous and fully instructed on how to avoid injury during its use.

 WARNING

To avoid the risk of electric shock and fire, the safety instructions of this guide must be observed and the guidelines followed.

2.5. Cleaning

When disconnected, the device may be cleaned with a cloth moistened with distilled water.

 WARNING

- The specifications must not be exceeded, and the device must only be applied as described in the following.
- Do not use the device near water or moisture.
- Do not install near any heat sources such as radiators, stoves or other heaters that produce heat.
- To prevent ignition of the explosive atmospheres, disconnect power before servicing and do not separate connectors when energized and an explosive gas mixture is present.
- Do not mount or remove devices from the power rail when an explosive gas mixture is present.
- Before the commissioning of the device, this installation guide must be examined carefully, and only qualified personnel (technicians) should install this device.
- If the equipment is used in a manner not specified by the manufacturer, the protection provided by the equipment may be impaired.

 CAUTION

To avoid the risk of explosion due to electrostatic charging of the enclosure, do not handle the units unless the area is known to be safe, or appropriate safety measures are taken to avoid electrostatic discharge.

3. DESCRIPTION

The signal converter is used in cases where the measurement device or transmitter analog signal type is not corresponding to the input of the processing unit. For example, you have a conductivity transmitter with 4-20mA output, but you have a PLC with only analog 0-10V signal input. Using this converter the 4-20mA signal is converted to 0-10V analog signal and it is cheaper than buying an analog input module for the PLC. Plus it is a 3 point galvanic isolator itself, which makes 3500VDC isolation between the input, output and power supply. The models can have voltage input and current output or current input and voltage output each type has a specific order code.

4. FEATURES

- Three way isolated
- 3500VDC isolation
- TS-35 DIN rail mounting
- +/-0.1% accuracy
- Ip40 case
- Screw terminals
- Power LED
- Supply voltage 24VDC
- Made in EU



5. INSTALLATION AND WIRING

The module is designed to be installed, in a vertical position, on TS-35 DIN rail. For the best module performance and duration, avoid placing objects that could obstruct the ventilation. Never install the modules near heat sources.

5.1. Installation on TS-35 DIN Rail

Inserting the Module in the Rail:

- 1) Attach the module in the lower part of the rail, as shown in the left figure below.
- 2) Press the module upwards.

Removing the Module in the Rail:

- 1) Apply leverage using a screwdriver, as shown in the right figure below.
- 2) Press the module downwards.

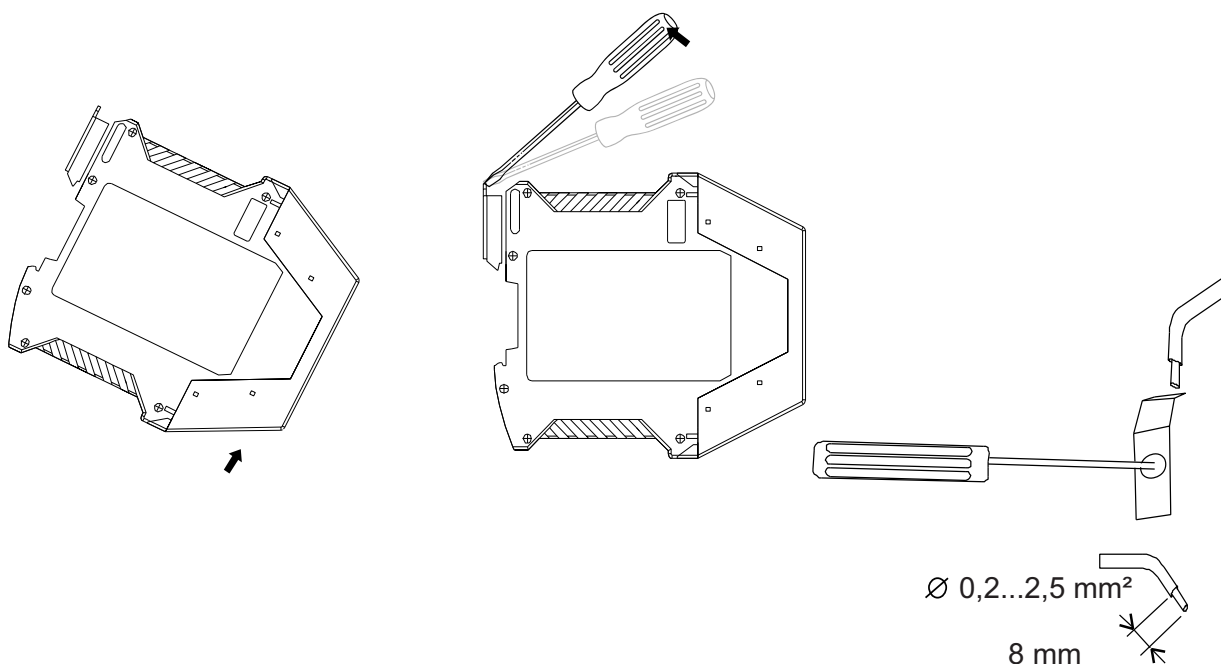

5.2. Connections with Screw Terminals

The module has been designed for screw-type terminal electrical connections. Proceed as follows to make the connections:

- 1) Strip the cables by 8mm.
- 2) Insert a screwdriver in hole, unscrewing the screw.
- 3) Insert the cable in the round hole.
- 4) Again, use the screwdriver to tighten the screw.
- 5) Remove the screwdriver and make sure that the cable is tightly fastened in the terminal.

6. SPECIFICATIONS

Voltage Input	
Number of inputs	1
Input Signal	Direct Voltage
Input Range	0-10V or 0-5V
Input Resistance	10K Ω
Current Input	
Number of inputs	1
Input Signal	Direct Current
Input Range	0(4)-20mA
Input Resistance	500 Ω
Voltage Output	
Number of outputs	1
Output Signal	Direct Voltage
Output Range	0-10V or 0-5V
Output Resistance	>1K Ω
Current Output	
Number of outputs	1
Output Signal	Direct Current
Output Range	0(4)-20mA on current loop
Output Resistance	<500 Ω
General	
Linearity error	0.10%
Output accuracy	0.10%
Limit frequency Voltage type	100Hz
Limit frequency Current type	1kHz
Response time	0.8ms
Isolation Voltage	3500V _{PEAK}
Working isolation voltage	400 V _{RMS}
Power Supply	
Supply Voltage	16 ~ 30VDC
Power Consumption	<58mA
Reverse-Polarity Protection	Yes
Enclosure	
IP Rating	IP40
Dimensions (L x D x H)	114 x 99 x 12.5 mm
Weight	82g (approx.)
Mounting	TS-35 DIN
Maximum Cable Cross-Section	2.5mm ² (max.)
Environmental Conditions	
Ambient Temperature Range	- 10 ~ +60 $^{\circ}$ C
Storage Temperature Range	- 30 ~ +80 $^{\circ}$ C
Humidity Level	0 ~ 95% RH at 40 $^{\circ}$ C, no condensation

7. CONFIGURATION TYPE AND ORDER CODE

Among the models available for this product, Levtech offers options that feature voltage input and current output or current input and voltage output. The voltages range from 0-5V and 0-10V, while the current options are 0-20mA and 4-20mA models. The LSP- IAC models have current input and the LSP-IVC have voltage input. The following table shows the ordering codes for each model.

Order Code	Input	Output
LSP-IVC-1020	0-10V	0-20mA
LSP-IVC-1042	0-10V	4-20mA
LSP-IVC-0520	0-5V	0-20mA
LSP-IVC-0542	0-5V	4-20mA
LSP-IAC-2010	0-20mA	0-10V
LSP-IAC-2005	0-20mA	0-5V
LSP-IAC-4210	4-20mA	0-10V
LSP-IAC-4205	4-20mA	0-5V
LSP-IAC-4202	4-20mA	0-20mA
LSP-IAC-0242	0-20mA	4-20mA

8. DIMENSIONS

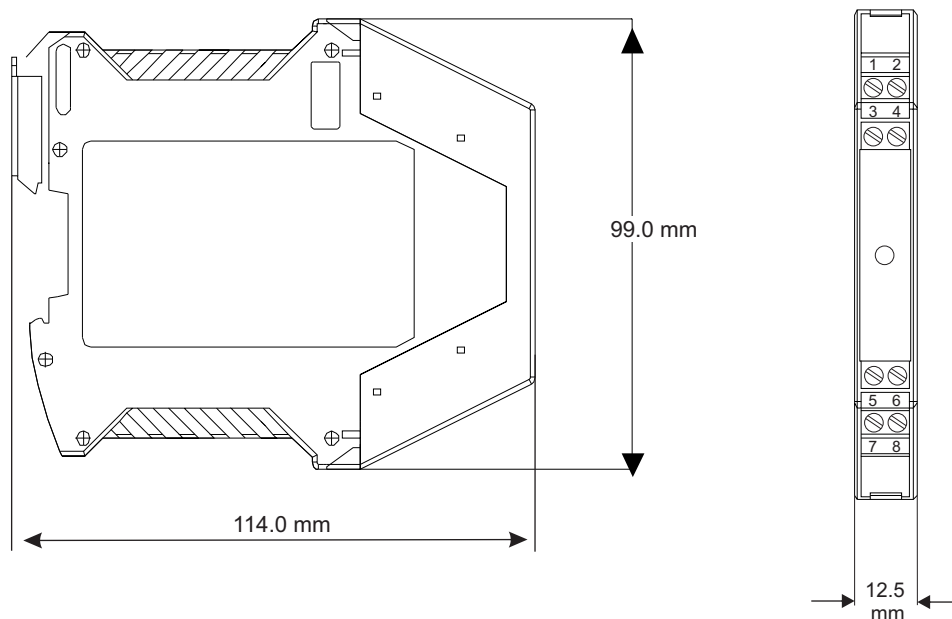

9. TERMINAL DESIGNATION

LSP-IVC-1020

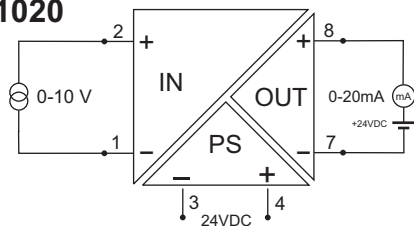

LSP-IAC-2010

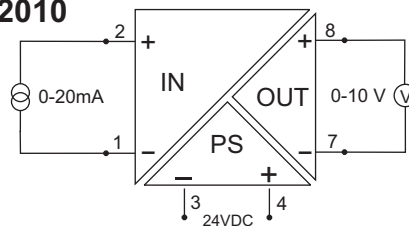

LSP-IVC-1042

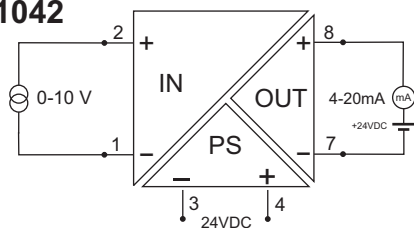

LSP-IAC-4210

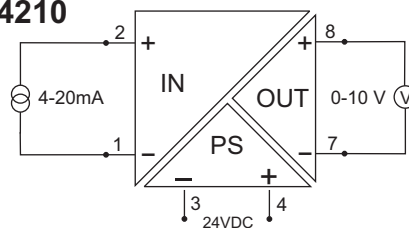

LSP-IVC-0520

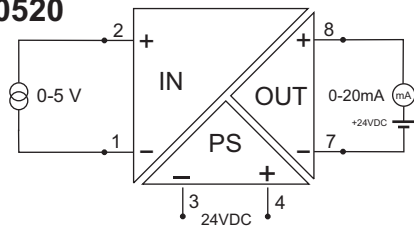

LSP-IAC-2005

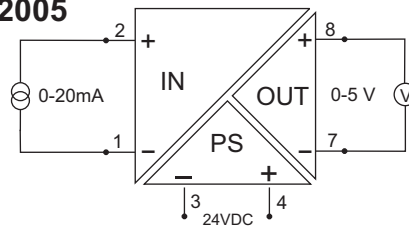

LSP-IVC-0542

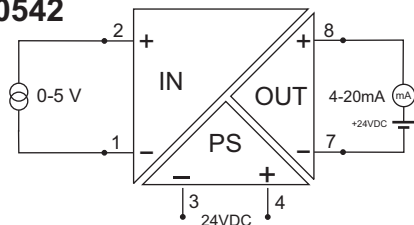

LSP-IAC-4205

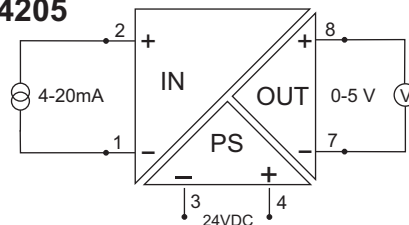

LSP-IVC-4202

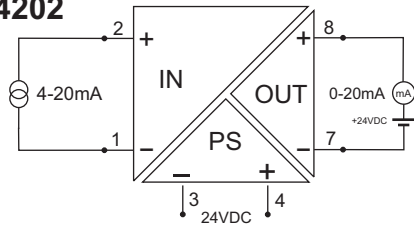

LSP-IVC-0242

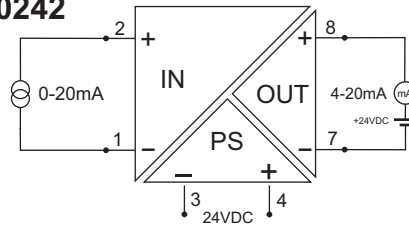

1. Negative Signal Input;
2. Positive Signal Input;
3. Negative Input of the Power Supply;
4. Positive Input of the Power Supply;

5. Negative Signal Output1;
6. Positive Signal Output1;
7. Negative Signal Output2;
8. Positive Signal Output2.

10. ELECTRICAL DIAGRAMS

LSP-IAC

This model features a current input and a voltage output. The input signal will be converted into voltage, which are isolated from each other and from the input signal. Check section 6 (“Configuration Type and Order Code”) to see the available options.

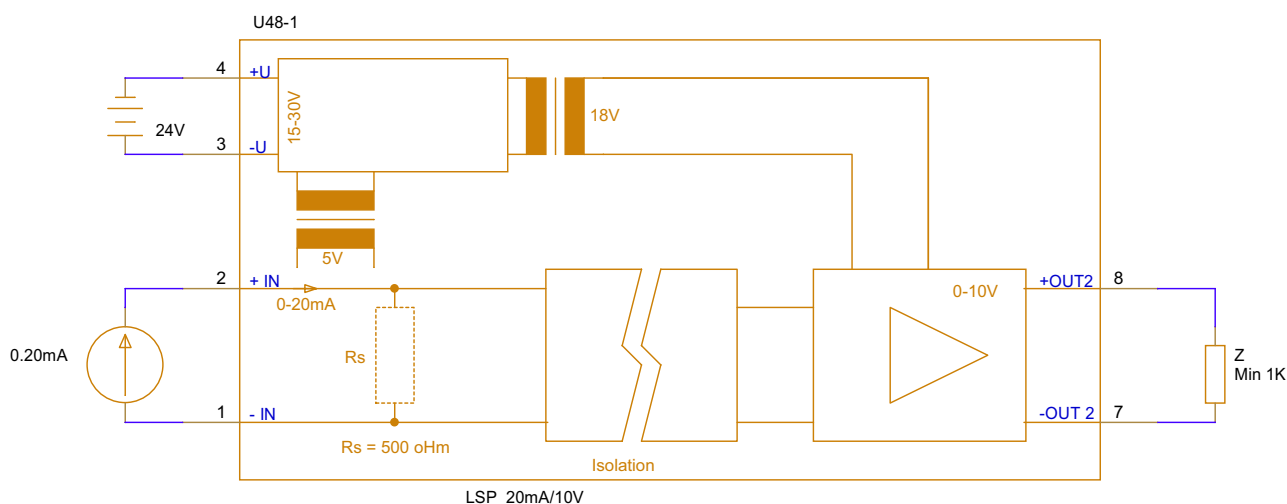

LSP-IVC

This models features a voltage input and a current output. The input signal will be converted into current, which are isolated from each other and from the input signal. Check section 6 (“Configuration Type and Order Code”) to see the available options.

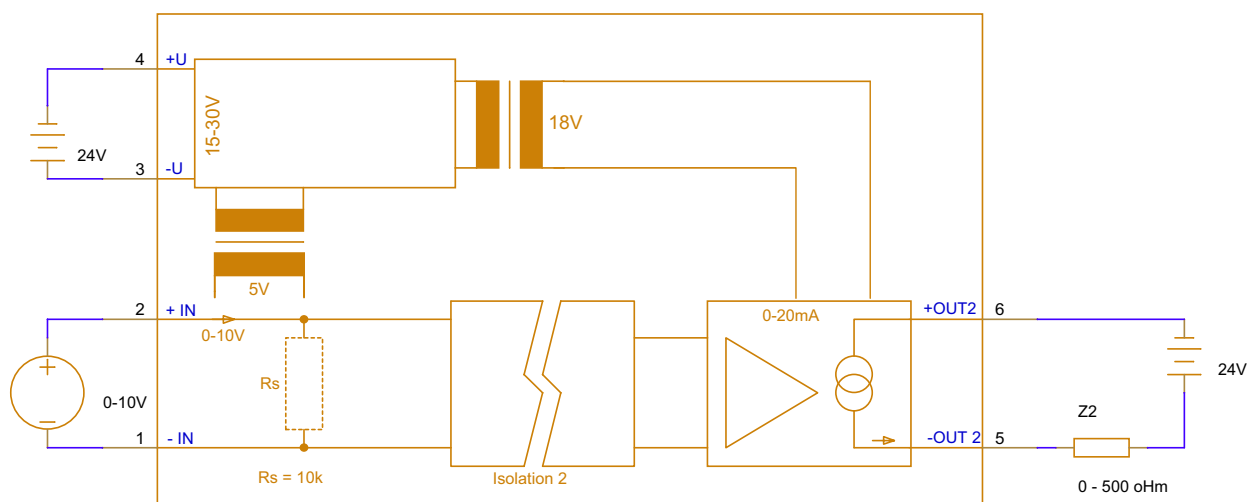

11.APPLICATIONS

This device can be used for several applications on industrial automation. It is ideal for removing errors caused by noise and signal interference, protecting sensitive equipment such as a PLC from potential hazards, and converting analog signals. The models can have voltage input and current output or current input and voltage output.

Example 1:

Suppose that you have a temperature sensor that operate in a 4-20mA current loop and you need to record the temperature in a PLC that allows input voltages from 0-10V. Therefore, you could use one of this isolated converter splitter to isolate the input signal and provide two isolated output signals.

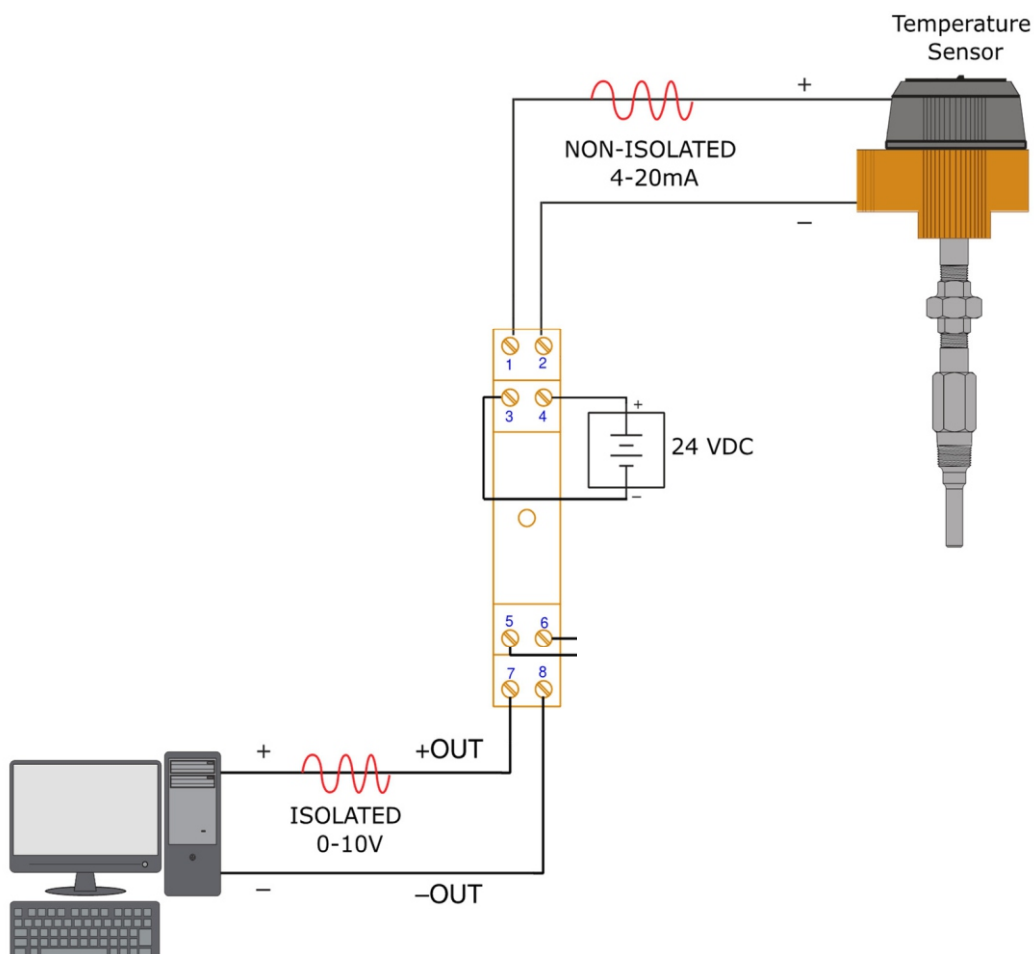

12. OPERATION AND MAINTENANCE

12.1. Operation

This isolator requires no user adjustments during commissioning. It comes with factory calibration ready for use.

If the isolator fails to operate, check for bad connections. In the unlikely event of the isolator not working, it should be returned to the supplier for repair or replacement.

12.2. Maintenance

Levtech suggests a quick check for terminal tightness and general unit condition. Always adhere to any site requirements for programmed maintenance.

13. WARRANTY DISCLAIMER

Levtech warrants this product to be free from significant deviations in material and workmanship for a period of 3 year from date of purchase. If repair or adjustment is necessary and has not been the result of abuse or misuse, within the 3 year period, please return-freight-prepaid and the correction of the defect will be made free of charge. If you purchased the item from our distributors and it is under warranty, please contact them to notify us of the situation. Levtech Service Department will determine if the product problem is due to deviations or customer misuse. Out-of-warranty products will be repaired on a charge basis.

13.1. Return of items

Authorization must be obtained from one of our representatives before returning items for any reason. When applying for authorization, have the model and serial number handy, including data regarding the reason for return. For your protection, items must be carefully packed to prevent damage in shipment and insured against possible damage or loss.

Levtech will not be responsible for damage resulting from careless or insufficient packing. A fee will be charged on all authorized returns.

Levtech reserves the right to make improvements in design, construction and appearance of our products without notice on which the buyer could reasonably have discovered the alleged defect or breach.

14. CONTACT INFORMATION



OPENING HOURS

Mon-Fri 8:00 AM – 18:00 PM
Sat 9:00 AM – 14:00 PM



ADDRESS

319 Lueta 537140 Harghita Romania



EMAIL

office@levtech.ro

ADDRESS

Lueta Nr. 319
Post Code 537140
Harghita
Romania

WEBSITE

<https://www.levtech.ro/>

SOCIAL MEDIA



Levtech



@levtechsp



@levtech_s_p

COMPANY DATA

LEVTECH SERVICE & PRODUCTION SRL
Fiscal code (CIF): RO35733217
Trade Register: RC J19/134/2016
IBAN: RO39RNCB0152150349440001
BCR BANK